

Specifications

- Current rating:7A AC,DC
- Voltage rating:250V AC,DC
- Temperature range:-25°C~+85°C
- Contact resistance:10mΩMax.
- Insulation resistance:1000MΩMin.
- Withstanding voltage:1000V AC/minute
- *Compliant with RoHS and REACH*
- *Meet the HF/Halogen Free,GWT/Glow wire Test (IEC60335-1) request,need to customize*
- *Contact HDGC for details*

Assembly layout

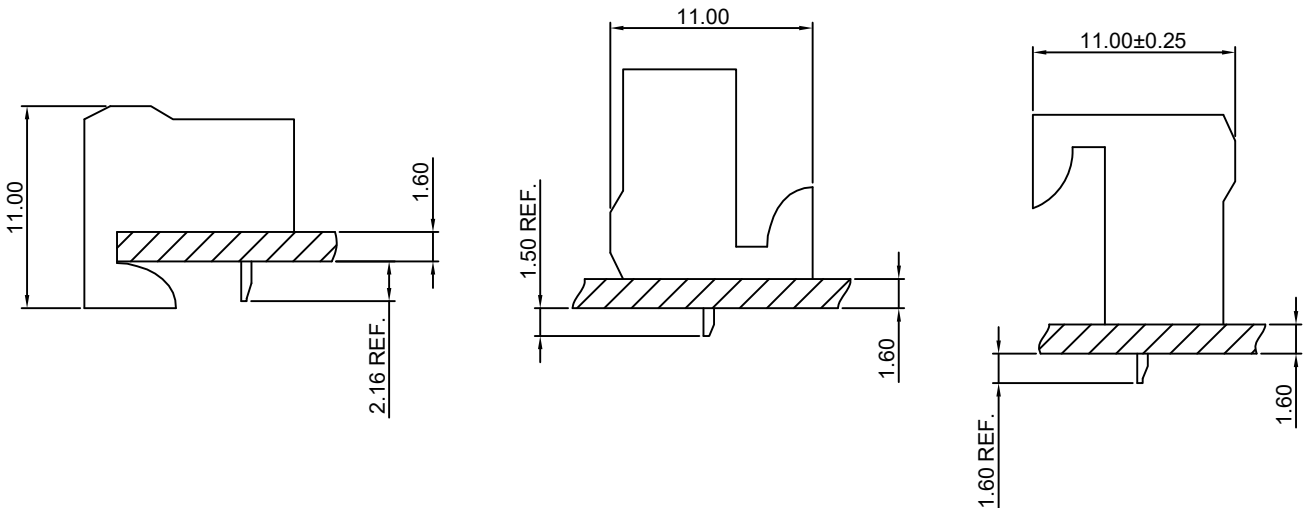



HDGC3966 Series 3.96mm (.156") Pitch Board to Board Connector

HDGC3966AW-XP

3.96mm Pitch PC Board Connector-Ringnt Angle

Reference Informations:

- *Material:
Terminal: Phosphor Bronze/Tin over Nickel
Housing: Nylon 66, UL94V-2
- *Mates with HDGC3966WV, WR, WVA, WRA-XP series Wafer
- *Color: White

Ordering Information:
HDGC3966AW-XP - ***
 1 2

1. Part No.
 2. Material:
 (blank): Nylon 66, UL94V-2/Natural
 V0: Nylon 66, UL94V-0/White
 GWT: Nylon 66, UL94V-0, GWT 750°C

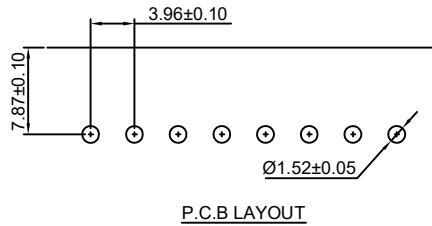
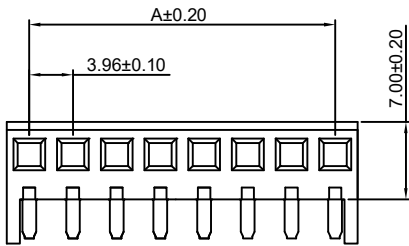
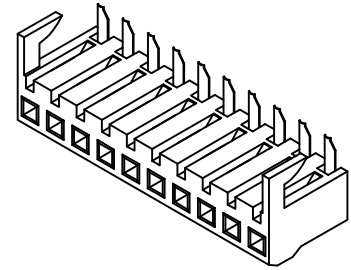

Ordering Information & Dimensions:

PART NO.	Dimensions	
	A	B
2P	3.96	8.06
3P	7.92	12.02
4P	11.88	15.98
5P	15.84	19.94
6P	19.80	23.90
7P	23.76	27.86
8P	27.72	31.82
9P	31.68	35.78
10P	35.64	39.74
11P	39.60	43.70
12P	43.56	47.66
13P	47.52	51.62
14P	51.48	55.58
15P	55.44	59.54
16P	59.40	63.50

Unit: mm

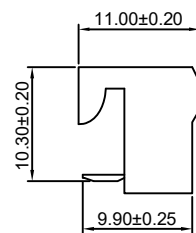
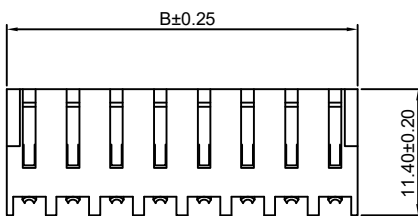

HDGC3966BW-XP

3.96mm Pitch PC Board Connector-Bottom Entry

Reference Informations:

- *Material:
Terminal: Phosphor Bronze/Tin over Nickel
Housing: Nylon 66, UL94V-2
- *Mates with HDGC3966WV, WR, WVA, WRA-XP series Wafer
- *Color: White

Ordering Information:
HDGC3966BW-XP - ***
 1 2

1. Part No.
 2. Material:
 (blank): Nylon 66, UL94V-2/Natural
 V0: Nylon 66, UL94V-0/White
 GWT: Nylon 66, UL94V-0, GWT 750°C

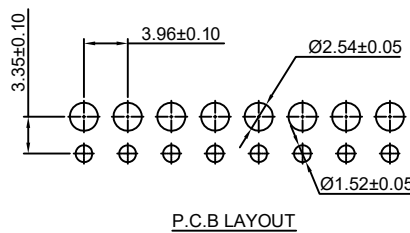
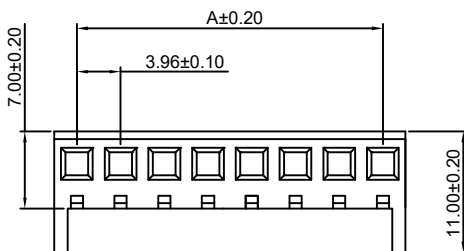
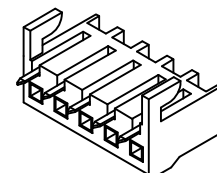

Ordering Information & Dimensions:

PART NO.	Dimensions	
	A	B
2P	3.96	8.06
3P	7.92	12.02
4P	11.88	15.98
5P	15.84	19.94
6P	19.80	23.90
7P	23.76	27.86
8P	27.72	31.82
9P	31.68	35.78
10P	35.64	39.74
11P	39.60	43.70
12P	43.56	47.66
13P	47.52	51.62
14P	51.48	55.58
15P	55.44	59.54
16P	59.40	63.50

Unit: mm

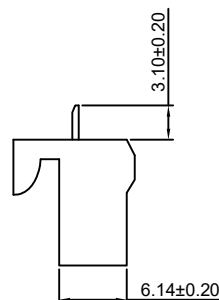
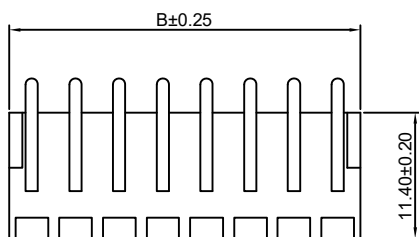



HDGC3966 Series 3.96mm (.156") Pitch Board to Board Connector

HDGC3966CW-XP

3.96mm Pitch PC Board Connector-Top Entry

Reference Informations:

*Material:

Terminal: Phosphor Bronze/Tin over Nickel
Housing: Nylon 66, UL94V-2

*Mates with HDGC3966WV, WR, WVA, WRA-XP series Wafer

*Color: White

Ordering Information:

HDGC3966CW-XP - ***
1 2

1. Part No.

2. Material:

(blank): Nylon 66, UL94V-2/Natural

V0: Nylon 66, UL94V-0/White

GWT: Nylon 66, UL94V-0, GWT 750°C

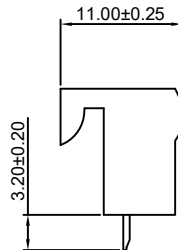
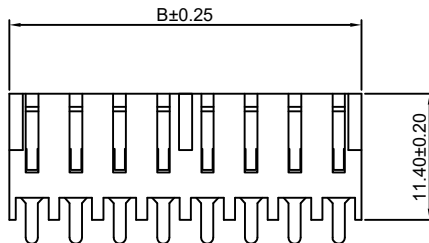
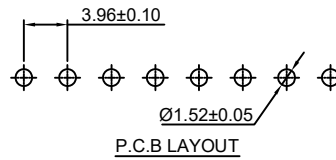
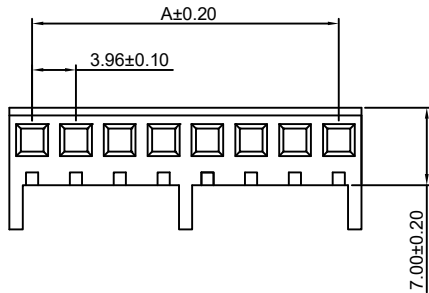
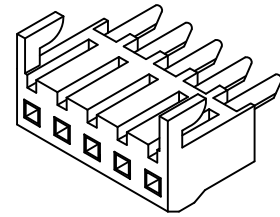

Ordering Information & Dimensions:

PART NO.	Dimensions	
	A	B
2P	3.96	8.06
3P	7.92	12.02
4P	11.88	15.98
5P	15.84	19.94
6P	19.80	23.90
7P	23.76	27.86
8P	27.72	31.82
9P	31.68	35.78
10P	35.64	39.74
11P	39.60	43.70
12P	43.56	47.66
13P	47.52	51.62
14P	51.48	55.58
15P	55.44	59.54
16P	59.40	63.50

Unit: mm