

修订 REV	标记 MARK	修改摘要 REVISION DESCRIPTION	签名 SIGNATURE	日期 DATE
AO		NEW RELEASE	WANG	2014-05-12

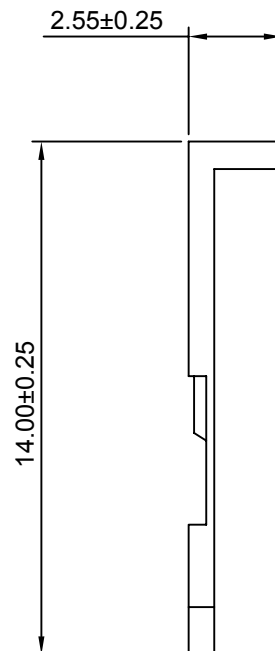

**SPECIFICATIONS:**  
 Current Rating: 3A AC,DC  
 Voltage Rating: 250V AC,DC  
 Temperature Range: -25°C ~ +85°C  
 Contact Resistance: 20mΩ Max  
 Insulation Resistance: 1000MΩ Min  
 Withstanding Voltage: 1500V AC/minute  
 Material: Nylon66, UL94V-0(Black)

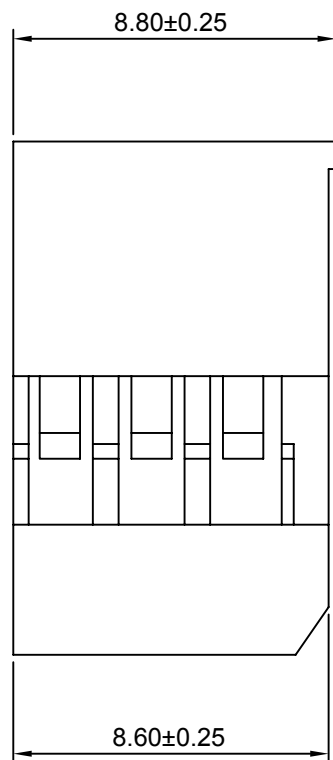
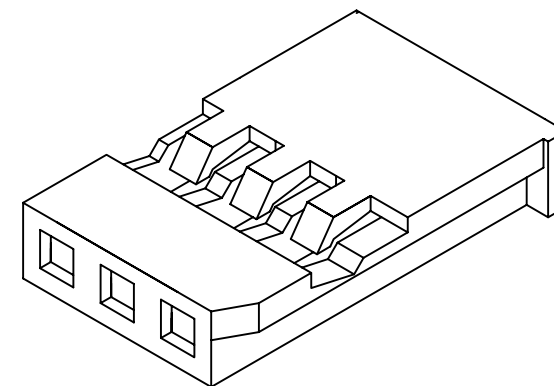
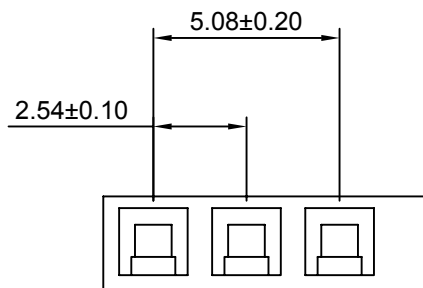

**深圳市华德共创科技有限公司**

Shenzhen Huade co-create Technology Co.,LTD  
 TEL : 0755-27129737 FAX : 0755-29940187

-TOLERANCES- UNLESS OTHERWISE SPECIFIED 公差参数表						TITLE: 2.00mm Pitch Housing 产品名称 :			
X.X	±0.30	X.X°	±3°	APPD: 核准 :	XIE	PART NO: HDGC2548HF-3P-P 产品编号 :			
X.XX	±0.30	X.XX°	±2°	CHECK: 校对 :	WANG	DATE	SCALE	UNIT	CODE NUMBER
X.XXX	±0.10	X.XXX°	±1°	DRAW: 绘图 :	WANG	2014-05-12	5:1	mm	A008

修订 REV	标记 MARK	修改摘要 REVISION DESCRIPTION	签名 SIGNATURE	日期 DATE
AO		NEW RELEASE	WANG	2014-05-12

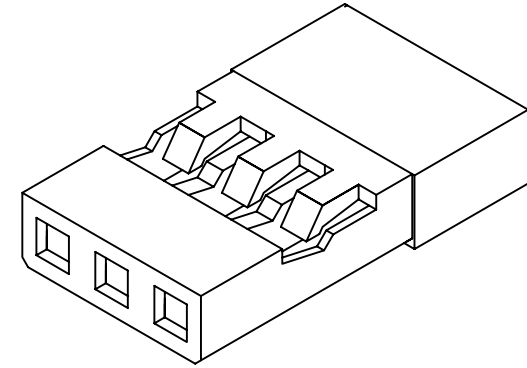
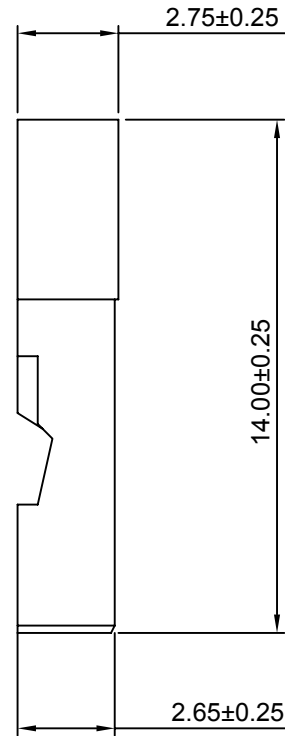
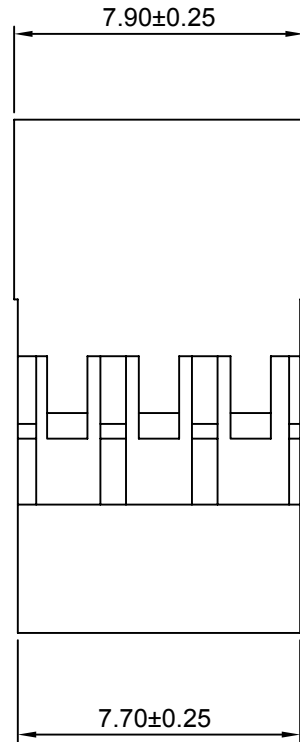
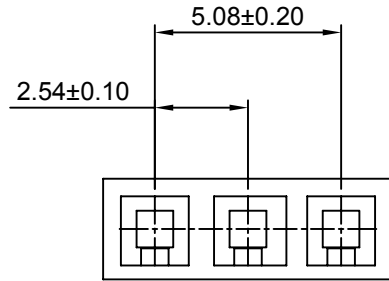

**SPECIFICATIONS:**  
 Current Rating: 3A AC,DC  
 Voltage Rating: 250V AC,DC  
 Temperature Range: -25°C ~ +85°C  
 Contact Resistance: 20mΩ Max  
 Insulation Resistance: 1000MΩ Min  
 Withstanding Voltage: 1500V AC/minute  
 Material: Nylon66, UL94V-0(Black)



**深圳市华德共创科技有限公司**

Shenzhen Huade co-create Technology Co.,LTD  
 TEL : 0755-27129737 FAX : 0755-29940187

-TOLERANCES- UNLESS OTHERWISE SPECIFIED 公差参数表						TITLE: 产品名称 : 2.00mm Pitch Housing			
X.X	±0.30	X.X°	±3°	APPD: 核准:	XIE	PART NO: 产品编号 : HDGC2548HF-3P-P			
X.XX	±0.30	X.XX°	±2°	CHECK: 校对:	WANG	DATE	SCALE	UNIT	CODE NUMBER
X.XXX	±0.10	X.XXX°	±1°	DRAW: 绘图:	WANG	2014-05-12	5:1	mm	A008

修订 REV	标记 MARK	修改摘要 REVISION DESCRIPTION	签名 SIGNATURE	日期 DATE
AO		NEW RELEASE	WANG	2014-05-12

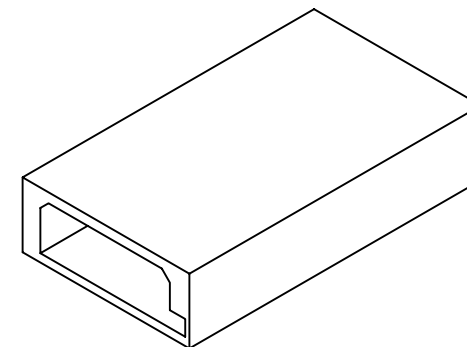
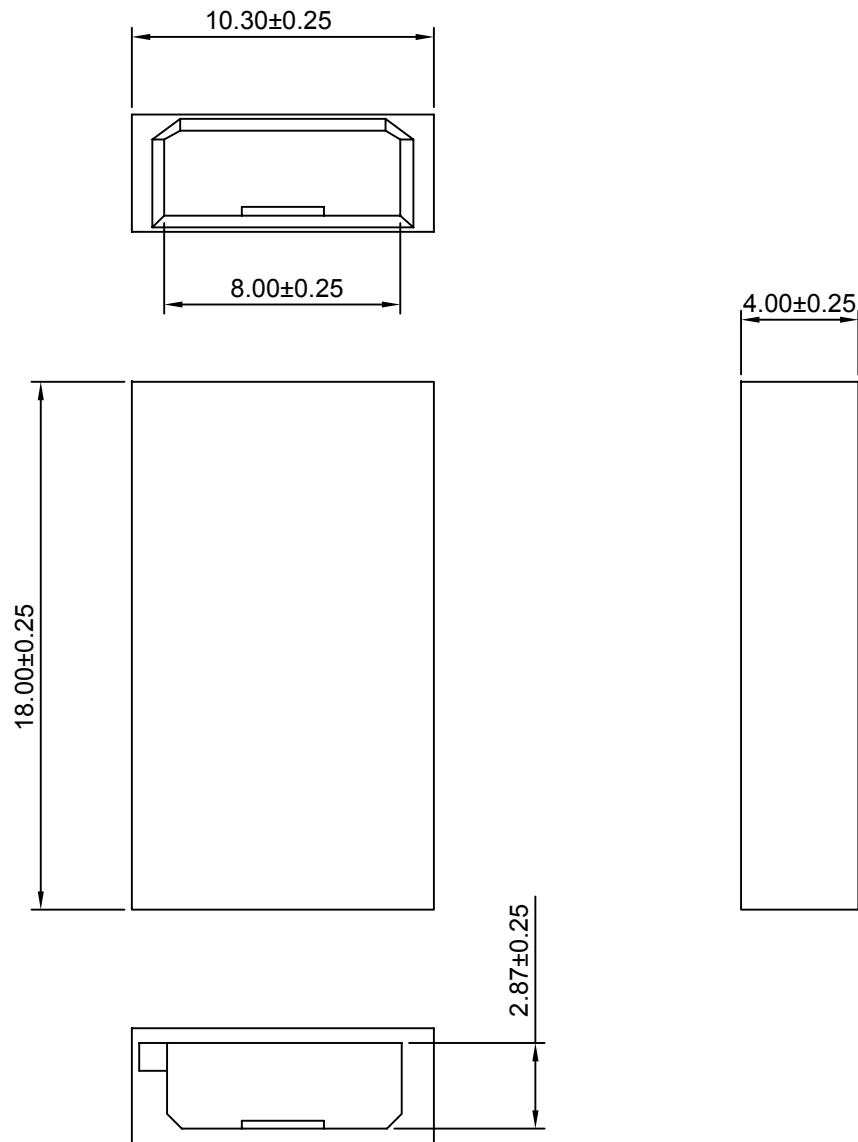

**SPECIFICATIONS:**  
 Current Rating: 3A AC,DC  
 Voltage Rating: 250V AC,DC  
 Temperature Range:  $-25^{\circ}\text{C} \sim +85^{\circ}\text{C}$   
 Contact Resistance: 20mΩ Max  
 Insulation Resistance: 1000MΩ Min  
 Withstanding Voltage: 1500V AC/minute  
 Material: Nylon66, UL94V-0(Black)

 <b>深圳市华德共创科技有限公司</b> Shenzhen Huade co-create Technology Co.,LTD TEL : 0755-27129737 FAX : 0755-29940187		TITLE: 2.00mm Pitch Housing						
		产品名称: 2.00mm Pitch Housing PART NO: HDGC2548HM-P-R 产品编号:						
-TOLERANCES- UNLESS OTHERWISE SPECIFIED 公差参数表		 						
X.X	$\pm 0.30$	X.X°	$\pm 3^{\circ}$	APPD: 核准: XIE CHECK: 校对: WANG DRAW: 绘图: WANG	DATE	SCALE	UNIT	CODE NUMBER
X.XX	$\pm 0.30$	X.XX°	$\pm 2^{\circ}$		2014-05-12	4:1	mm	A008
X.XXX	$\pm 0.10$	X.XXX°	$\pm 1^{\circ}$					

修订 REV	标记 MARK	修改摘要 REVISION DESCRIPTION	签名 SIGNATURE	日期 DATE
AO		NEW RELEASE	WANG	2014-05-12

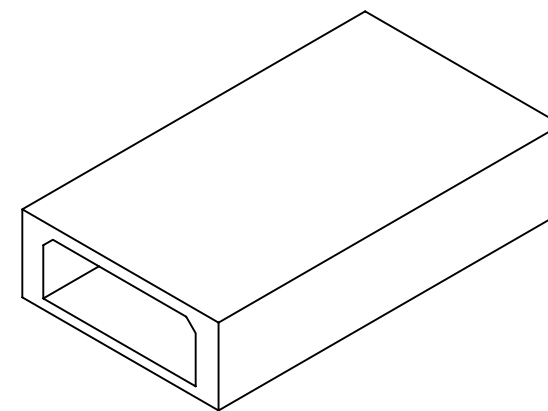
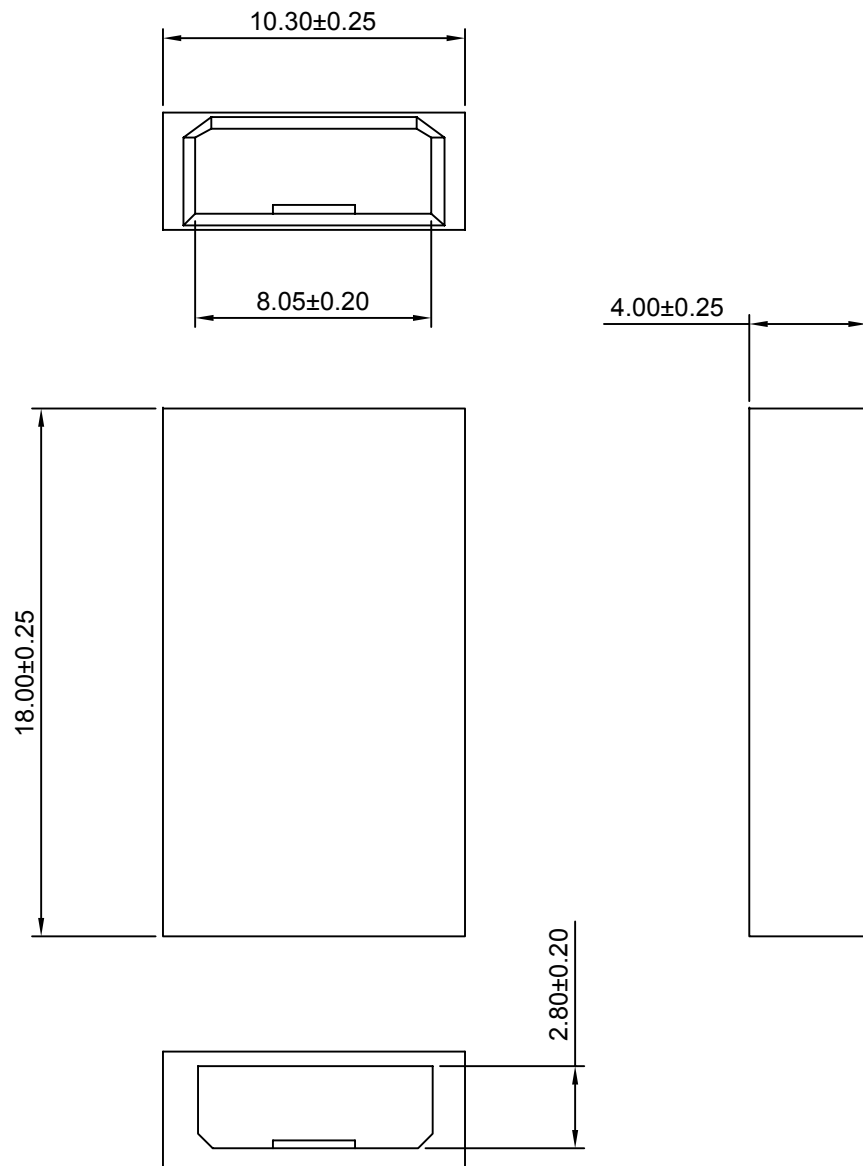

**SPECIFICATIONS:**  
 Current Rating: 3A AC,DC  
 Voltage Rating: 250V AC,DC  
 Temperature Range: -25°C ~ +85°C  
 Contact Resistance: 20mΩ Max  
 Insulation Resistance: 1000MΩ Min  
 Withstanding Voltage: 1500V AC/minute  
 Material: Nylon66, UL94V-0(Black)



深圳市华德共创科技有限公司

Shenzhen Huade co-create Technology Co.,LTD  
 TEL : 0755-27129737 FAX : 0755-29940187

-TOLERANCES- UNLESS OTHERWISE SPECIFIED 公差参数表						TITLE: 2.00mm Pitch Housing 产品名称 :			
X.X	±0.30	X.X°	±3°	APPD: 核准:	XIE	PART NO: 产品编号: HDGC2548HM-R-R			
X.XX	±0.30	X.XX°	±2°	CHECK: 校对:	WANG	DATE	SCALE	UNIT	CODE NUMBER
X.XXX	±0.10	X.XXX°	±1°	DRAW: 绘图:	WANG	2014-05-12	4:1	mm	A008

修订 REV	标记 MARK	修改摘要 REVISION DESCRIPTION	签名 SIGNATURE	日期 DATE
AO		NEW RELEASE	WANG	2014-05-12

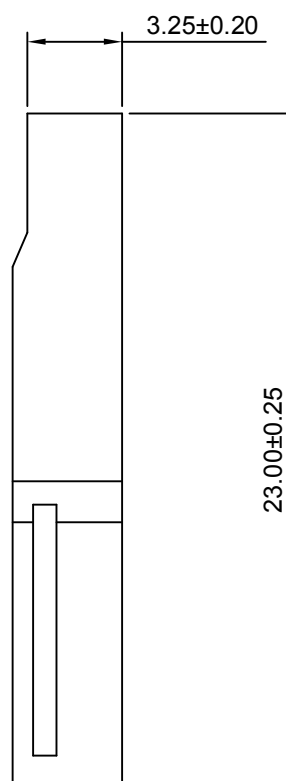
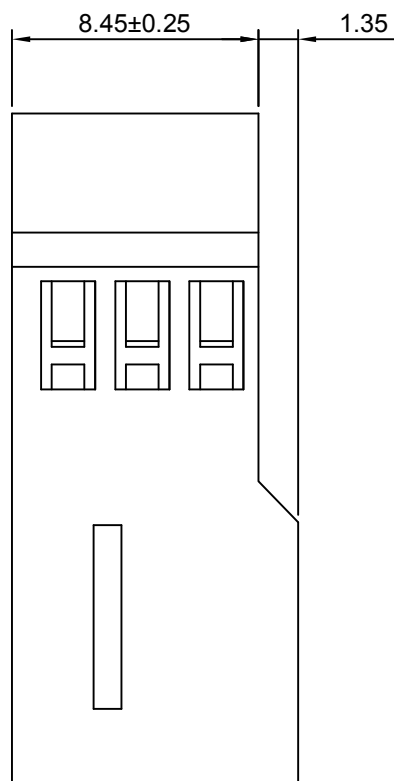
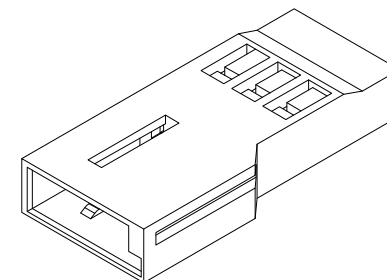
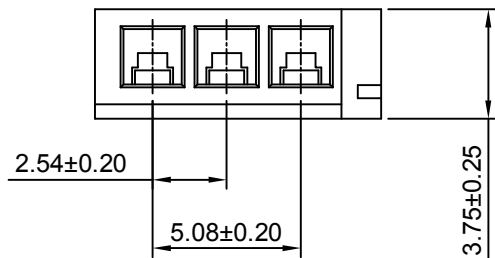

**SPECIFICATIONS:**  
 Current Rating: 3A AC,DC  
 Voltage Rating: 250V AC,DC  
 Temperature Range: -25°C ~ +85°C  
 Contact Resistance: 20mΩ Max.  
 Insulation Resistance: 1000MΩ Min.  
 Withstanding Voltage: 1500V AC/minute  
 Material: PBT UL94V-0(Brick red)



**深圳市华德共创科技有限公司**

Shenzhen Huade co-create Technology Co.,LTD  
 TEL : 0755-27129737 FAX : 0755-29940187

-TOLERANCES- UNLESS OTHERWISE SPECIFIED 公差参数表				 		TITLE: 产品名称 : 2.00mm Pitch Housing			
X.X	±0.30	X.X°	±3°	APPD: 核准 :	XIE	PART NO: 产品编号 : HDGC2548HMA-3P-BRD			
X.XX	±0.30	X.XX°	±2°	CHECK: 校对 :	WANG	DATE	SCALE	UNIT	CODE NUMBER
X.XXX	±0.10	X.XXX°	±1°	DRAW: 绘图 :	WANG	2014-05-12	4:1	mm	A008