

修订 REV	标记 MARK	修改摘要 REVISION DESCRIPTION	签名 SIGNATURE	日期 DATE
AO		NEW RELEASE	WANG	2013-05-07

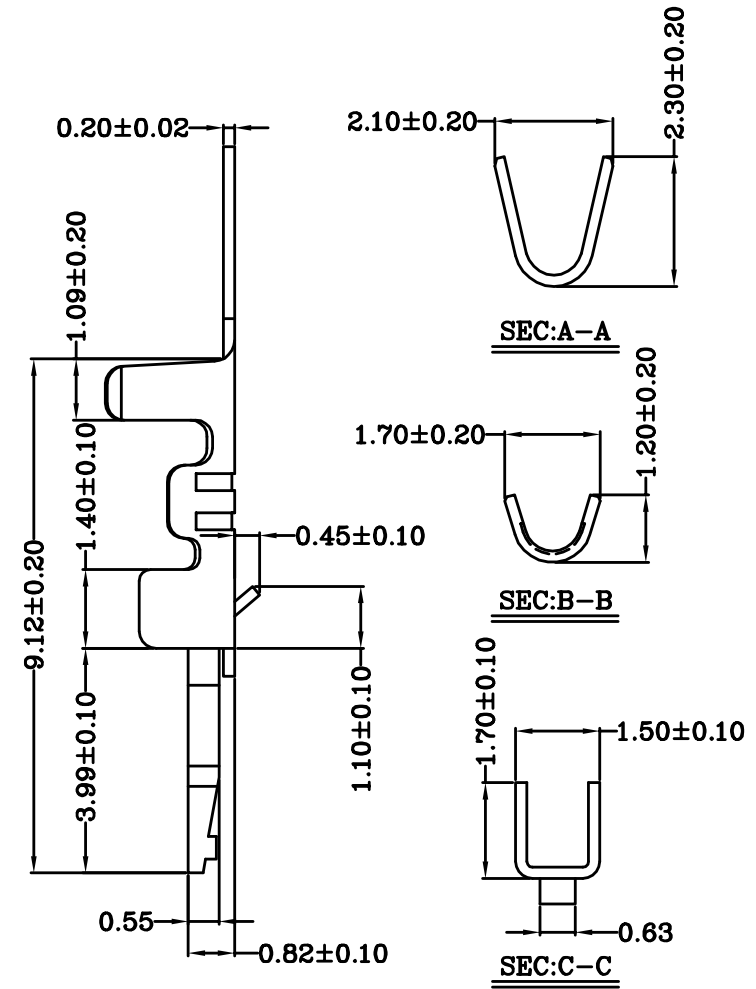
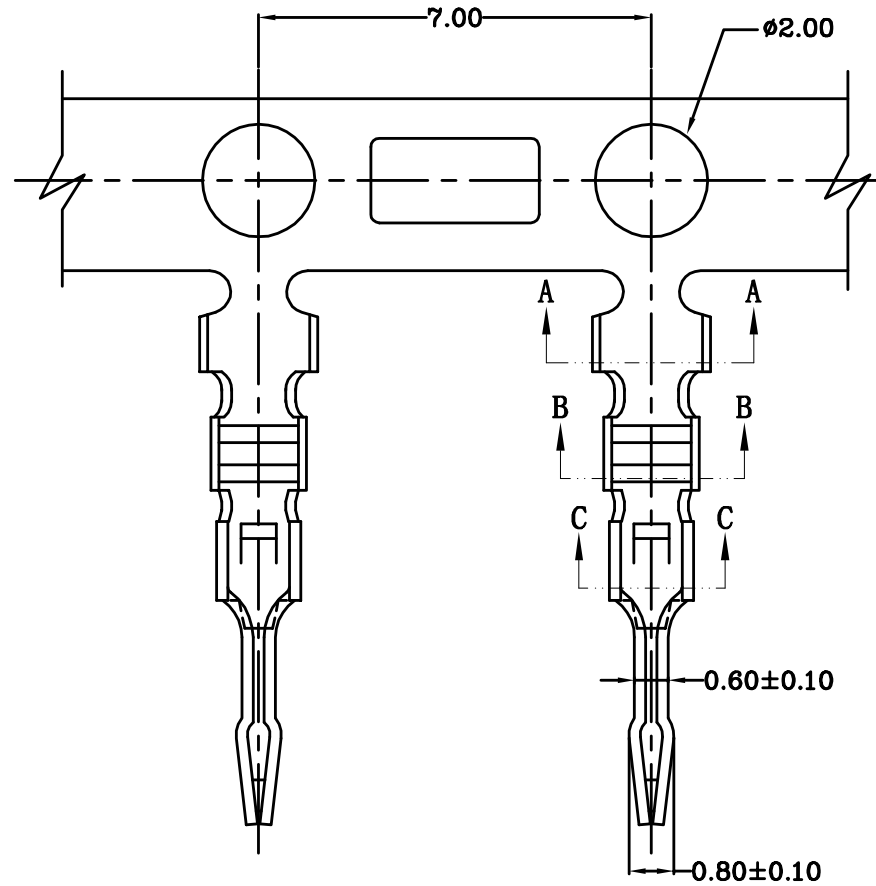

NOTE:

1. MATERIAL :BRASS H65 T= 0.20 ± 0.02 MM
2. 0.05mm BURR ALLOWABLE.

 深圳市华德共创科技有限公司 Shenzhen Huade co-create Technology Co.,LTD TEL : 0755-27129737 FAX : 0755-29940187				TITLE: 2.00mm Pitch 产品名称: Crimp Terminal					
-TOLERANCES- UNLESS OTHERWISE SPECIFIED 公差参数表				 		PART NO: 产品编号: HDGC2015-T			
X.X	± 0.30	X.X°	$\pm 3^\circ$	APPD: 核准:	XIE	DATE	SCALE	UNIT	CODE NUMBER
X.XX	± 0.30	X.XX°	$\pm 2^\circ$	CHECK: 校对:	WANG	2013-05-07	8:1	mm	A001
X.XXX	± 0.10	X.XXX°	$\pm 1^\circ$	DRAW: 绘图:	WANG				

修订 REV	标记 MARK	修改摘要 REVISION DESCRIPTION	签名 SIGNATURE	日期 DATE
AO		NEW RELEASE	WANG	2019-12-23

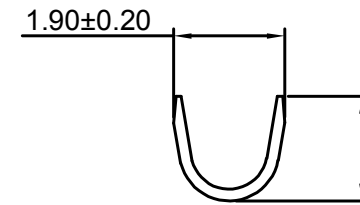
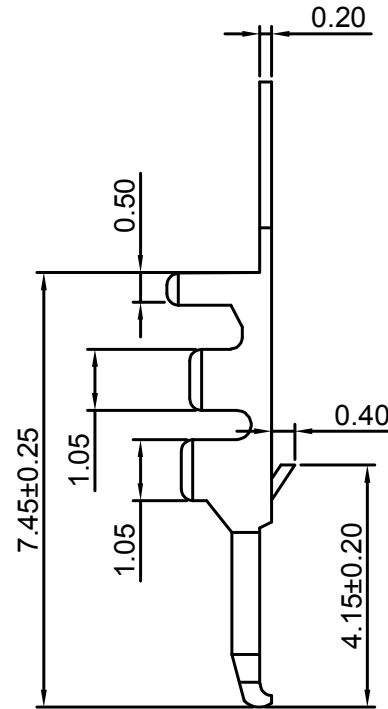
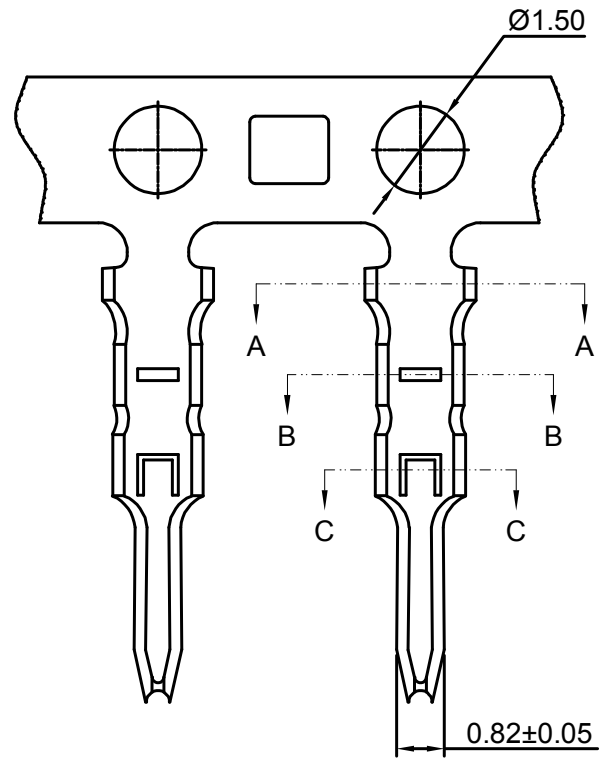

SEC:A-A

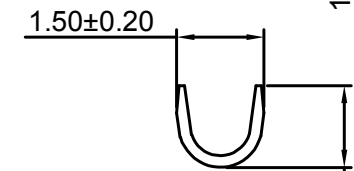

SEC:B-B

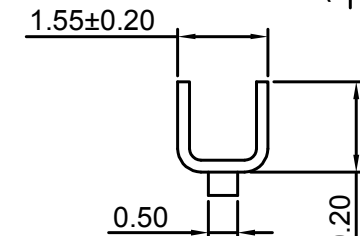

SEC:C-C

Ordering information & Specifications:

Unit:mm

Part NO.	Wire Range	Insulation O.D.	Material	Finish	Qty/reel
HDGC2015-TB-A	AWG#28-#30	1.00mm(max)	Brass	Tin over Nickel	10,000 PCS
HDGC2015-TP-A	AWG#28-#30	1.00mm(max)	Phosphor Bronze	Tin over Nickel	10,000 PCS
HDGC2015-GB-A	AWG#28-#30	1.00mm(max)	Brass	Gold over Nickel	10,000 PCS
HDGC2015-GP-A	AWG#28-#30	1.00mm(max)	Phosphor Bronze	Gold over Nickel	10,000 PCS

Optional Gold plating available but MOQ requested



深圳市华德共创科技有限公司

Shenzhen Huade co-create Technology Co.,LTD

TEL : 0755-27129737 FAX : 0755-29940187

-TOLERANCES- UNLESS OTHERWISE SPECIFIED 公差参数表					TITLE: 2.00mm Pitch 产品名称: Crimp Terminal			
X.X	±0.30	X.X°	±3°	APPD: 核准: XIE	PART NO: 产品编号: HDGC2015-T-A			
X.XX	±0.30	X.XX°	±2°	CHECK: 校对: WANG	DATE	SCALE	UNIT	CODE NUMBER
X.XXX	±0.10	X.XXX°	±1°	DRAW: 绘图: WANG	2019-12-23	8:1	mm	A008

修订 REV	标记 MARK	修改摘要 REVISION DESCRIPTION	签名 SIGNATURE	日期 DATE
AO		NEW RELEASE	WANG	2019-12-23

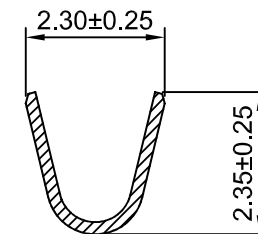
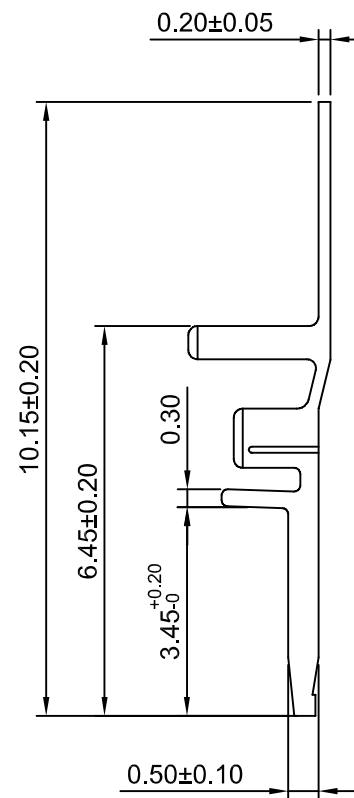
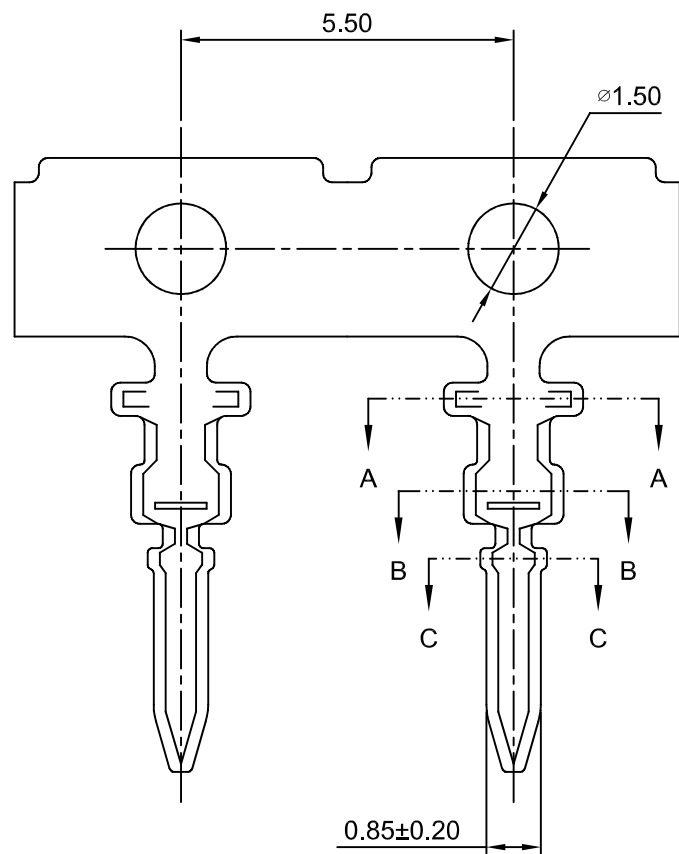

SEC:A-A

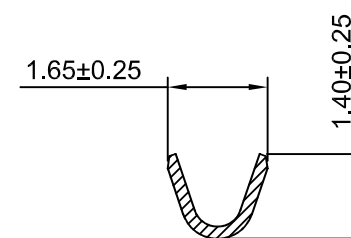

SEC:B-B

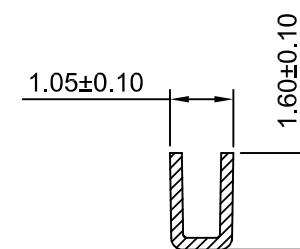

SEC:C-C

Ordering information & Specifications

Unit:mm

Part No	Wire Range	Insulation O.D.	Material	Finish	Qty/reel
HDGC2015-TP-B	AWG#24-#28	1.20mm(max)	Phosphor Bronze	Tin over Nickel	15,000 PCS
HDGC2015-GP-B	AWG#24-#28	1.20mm(max)	Phosphor Bronze	Gold over Nickel	15,000 PCS



深圳市华德共创科技有限公司

Shenzhen Huade co-create Technology Co.,LTD

TEL : 0755-27129737 FAX : 0755-29940187

-TOLERANCES- UNLESS OTHERWISE SPECIFIED 公差参数表					TITLE: 产品名称: 2.00mm Pitch Crimp Terminal			
X.X	±0.30	X.X°	±3°	APPD: 核准: XIE	PART NO: 产品编号: HDGC2015-T-B			
X.XX	±0.30	X.XX°	±2°	CHECK: 校对: WANG	DATE	SCALE	UNIT	CODE NUMBER
X.XXX	±0.10	X.XXX°	±1°	DRAW: 绘图: WANG	2019-12-23	8:1	mm	A008

修订 REV	标记 MARK	修改摘要 REVISION DESCRIPTION	签名 SIGNATURE	日期 DATE
AO		NEW RELEASE	WANG	2019-12-23

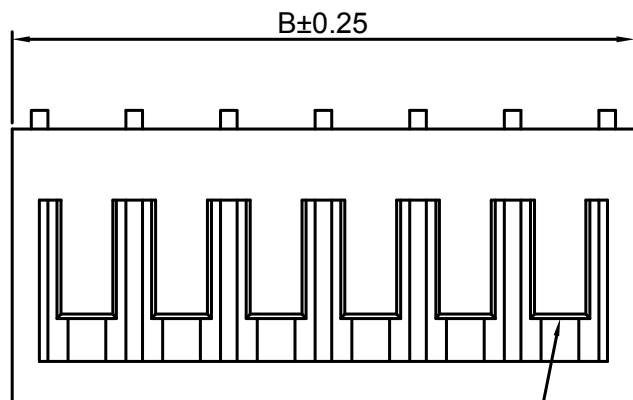
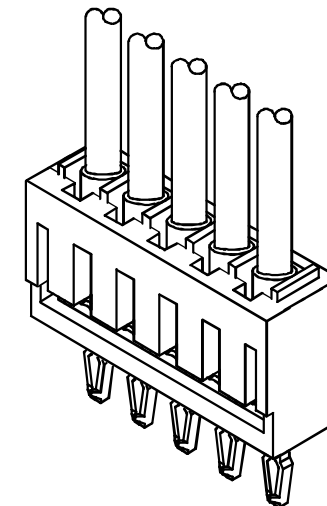
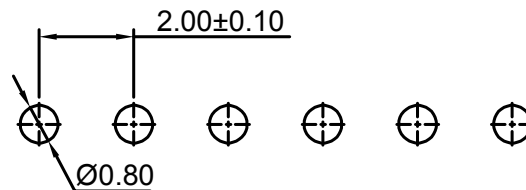
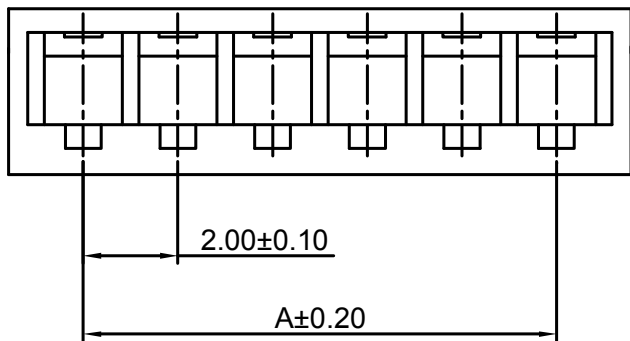

Circuit 1

P.C.B LAYOUT

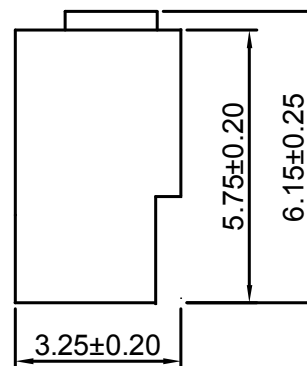

Ordering Information & Dimensions

Circuits	Dimensions(mm)		Circuits	Dimensions(mm)	
	A	B		A	B
2P	2.00	5.20	11P	20.00	23.20
3P	4.00	7.20	12P	22.00	25.20
4P	6.00	9.20	13P	24.00	27.20
5P	8.00	11.20	14P	26.00	29.20
6P	10.00	13.20	15P	28.00	31.20
7P	12.00	15.20	16P	30.00	33.20
8P	14.00	17.20	17P	32.00	35.20
9P	16.00	19.20	18P	34.00	37.20
10P	18.00	21.20			

SPECIFICATIONS:

Current Rating: 1A AC,DC
Voltage Rating: 250V AC,DC
Temperature Range: -25°C ~ +85°C
Contact Resistance: 20mΩ Max
Insulation Resistance: 500MΩ Min
Withstanding Voltage: 1000V AC/minute
Material: Nylon 66,UL94V-0(White)



深圳市华德共创科技有限公司

Shenzhen Huade co-create Technology Co.,LTD

TEL : 0755-27129737 FAX : 0755-29940187

-TOLERANCES- UNLESS OTHERWISE SPECIFIED 公差参数表				TITLE: 产品名称: 2.00mm Pitch Housing	
X.X	±0.30	X.X°	±3°	APPD: 核准:	XIE
X.XX	±0.30	X.XX°	±2°	CHECK: 校对:	WANG
X.XXX	±0.10	X.XXX°	±1°	DRAW: 绘图:	WANG
PART NO: 产品编号:		HDGC2015H-XP			
DATE	SCALE	UNIT	CODE NUMBER		
2019-12-23	8:1	mm	A001		

修订 REV	标记 MARK	修改摘要 REVISION DESCRIPTION	签名 SIGNATURE	日期 DATE
AO		NEW RELEASE	WANG	2019-12-23

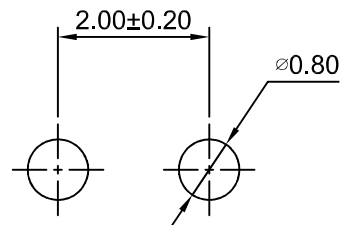
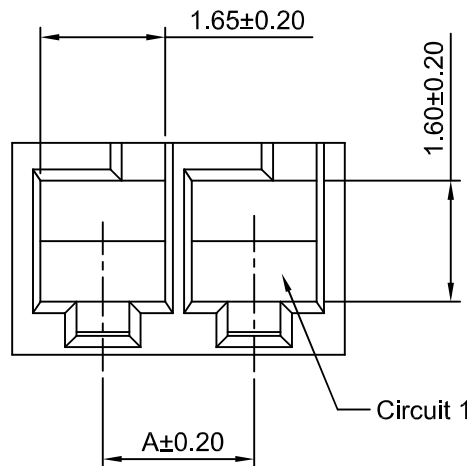

P.C.B LAYOUT

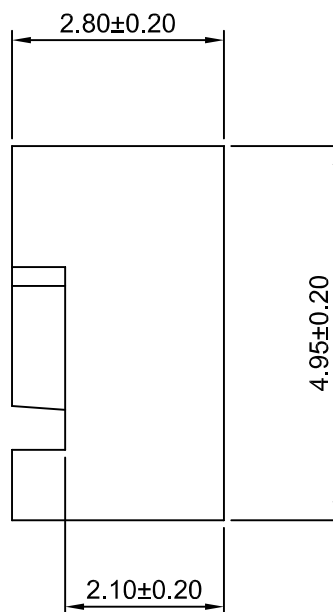
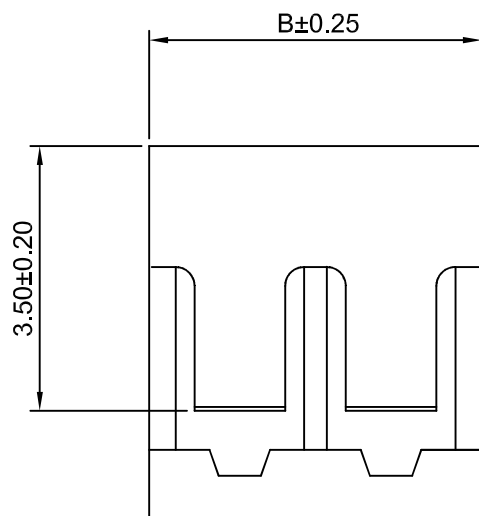

SPECIFICATIONS:

Current Rating: 1A AC,DC
Voltage Rating: 250V AC,DC
Temperature Range: -25°C ~ +85°C
Contact Resistance: 20mΩ Max
Insulation Resistance: 500MΩ Min
Withstanding Voltage: 1000V AC/minute
Material: Nylon 66,UL94V-0(White)

Ordering Information & Dimensions

Circuits	Dimensions(mm)		Circuits	Dimensions(mm)	
	A	B		A	B
2P	2.00	4.40	10P	18.00	20.40
3P	4.00	6.40	11P	20.00	22.40
4P	6.00	8.40	12P	22.00	24.40
5P	8.00	10.40	13P	24.00	26.40
6P	10.00	12.40	14P	26.00	28.40
7P	12.00	14.40	15P	28.00	30.40
8P	14.00	16.40	16P	30.00	32.40
9P	16.00	18.40			



深圳市华德共创科技有限公司

Shenzhen Huade co-create Technology Co.,LTD

TEL : 0755-27129737 FAX : 0755-29940187

-TOLERANCES- UNLESS OTHERWISE SPECIFIED 公差参数表						TITLE: 产品名称: 2.00mm Pitch Housing			
X.X	±0.30	X.X°	±3°	APPD: 核准:	XIE	PART NO: 产品编号: HDGC2015HA-XP			
X.XX	±0.30	X.XX°	±2°	CHECK: 校对:	WANG	DATE	SCALE	UNIT	CODE NUMBER
X.XXX	±0.10	X.XXX°	±1°	DRAW: 绘图:	WANG	2019-12-23	10:1	mm	A001

修订 REV	标记 MARK	修改摘要 REVISION DESCRIPTION	签名 SIGNATURE	日期 DATE
AO		NEW RELEASE	WANG	2019-12-23

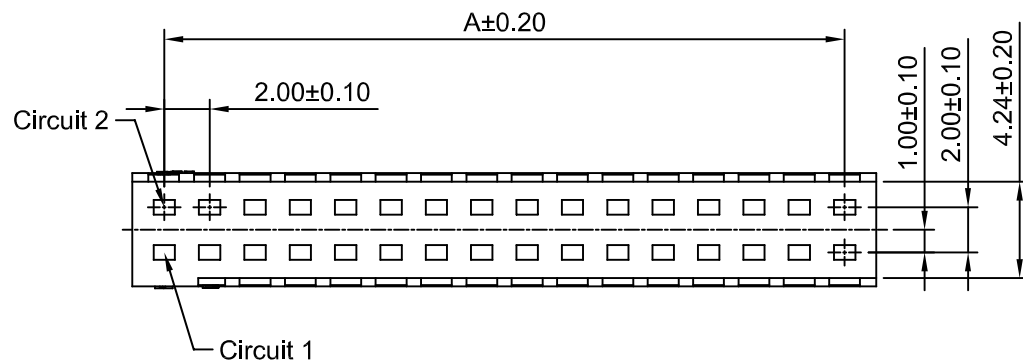
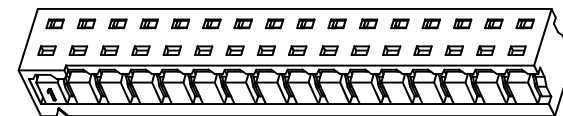
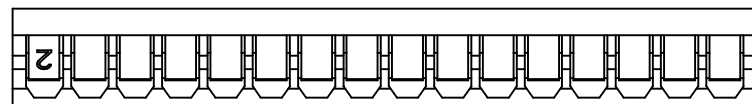

SPECIFICATIONS:

Current Rating: 3A AC,DC
Voltage Rating: 250V AC,DC
Temperature Range: -25°C ~ +85°C
Contact Resistance: 30mΩ Max
Insulation Resistance: 1000MΩ Min
Withstanding Voltage: 650V AC/minute
Material: Nylon 9T,UL94V-0(Black)

Ordering Information & Dimensions

Circuits	Dimensions(mm)		Circuits	Dimensions(mm)	
	A	B		A	B
2x2P	2.00	4.80	2x10P	18.00	20.80
2x3P	4.00	6.80	2x11P	20.00	22.80
2x4P	6.00	8.80	2x12P	22.00	24.80
2x5P	8.00	10.80	2x13P	24.00	26.80
2x6P	10.00	12.80	2x14P	26.00	28.80
2x7P	12.00	14.80	2x15P	28.00	30.80
2x8P	14.00	16.80	2x16P	30.00	32.80
2x9P	16.00	18.80			

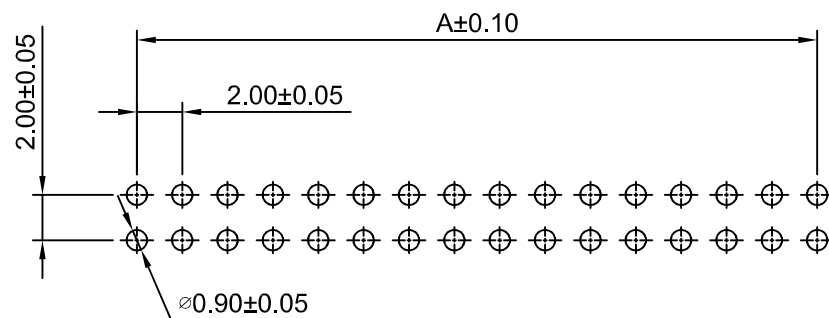
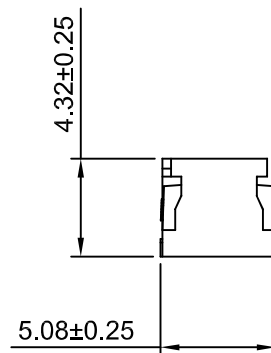
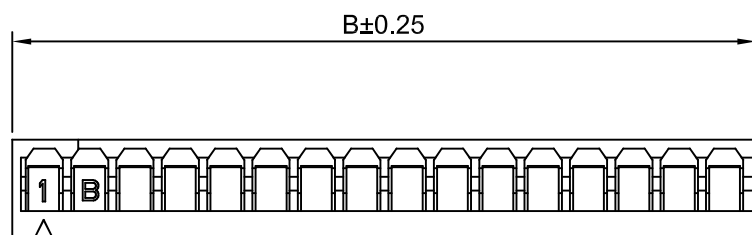

P.C.B LAYOUT

深圳市华德共创科技有限公司
Shenzhen Huade co-create Technology Co.,LTD
TEL : 0755-27129737 FAX : 0755-29940187

-TOLERANCES- UNLESS OTHERWISE SPECIFIED 公差参数表					TITLE: 产品名称: 2.00mm Pitch Housing			
X.X	±0.30	X.X°	±3°	APPD: 核准: XIE	PART NO: 产品编号: HDGC2015H-2xXP			
X.XX	±0.30	X.XX°	±2°	CHECK: 校对: WANG	DATE	SCALE	UNIT	CODE NUMBER
X.XXX	±0.10	X.XXX°	±1°	DRAW: 绘图: WANG	2019-12-23	3:1	mm	A001